



PRATLEY

www.pratley.com

ALUMINIUM ALLOY JUNCTION BOX



SANS 60529
SANS 61241
SABS APPROVED
IP66/68 DIP B20 Ta T6

FIRE RESISTANT



SPECIAL CERTIFICATION FOR FIRE SURVIVAL OF ELECTRICAL EQUIPMENT

ALUMINIUM TUNNEL JUNCTION BOX

SUPPLIED COMPLETE WITH BUILT-IN GLANDS

ALUMINIUM ALLOY JUNCTION BOX

CERTIFICATION



I.A. No. SABS S/05-014X

IP66/68 (2m Cont.)
SANS(IEC) 60529
SANS(IEC) 61241
DIP B20 Ta T6
Zone 1, 2, 20, 21 & 22

ALUMINIUM ALLOY TUNNEL BOX

SPECIAL CERTIFICATION FOR FIRE SURVIVAL OF ELECTRICAL EQUIPMENT

IP68 SABS APPROVED BS6387

• TEST REPORT N°FPE/85066/09

FEATURES & BENEFITS

- Tunnel Boxes are specially designed and certified for use in tunnels where fire & smoke considerations are paramount (with special silicone shrouds).
- Unique built-in glands
- For use with armoured cable(s)
- Easily convertible for unarmoured cable
- For all surface applications*
- Lightweight and impact resistant
- Epoxy coated for corrosion resistance
- Range of configurations & sizes
- Internal and external earthing boss/lug.
- Accessories for a wide range of uses

*Not to be buried underground

POLICY STATEMENT

"The performance of our products must exceed all others on the world market"

KGM Pratley
CEO

PRATLEY ALUMINIUM ALLOY CABLE BOX CONFIGURATIONS & SIZES

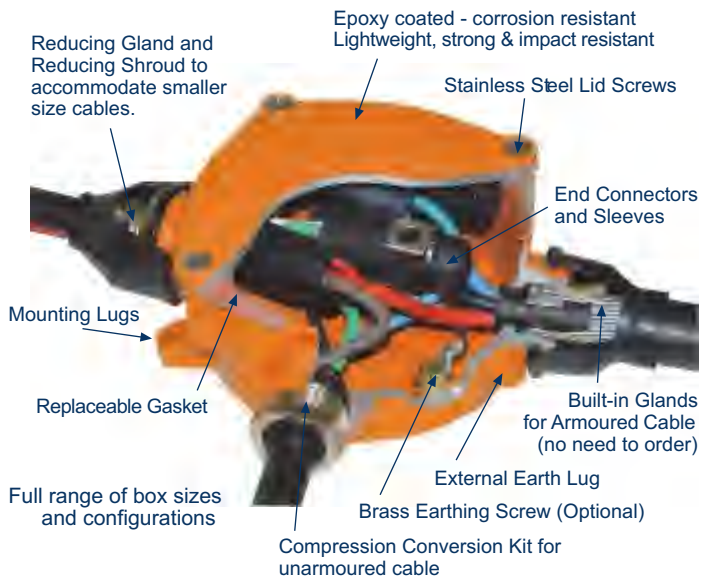

ALUMINIUM ALLOY CABLE BOX SIZES & CONFIGURATIONS		
Size	Configuration	Cat. No.
No. 0	Two way through box	08041
	Three way right angle	08042
	Four way right angle	08043
No. 1	Two way through box	08044
	Three way right angle	08045
	Four way right angle	08046
No. 1	Three way Y-type parallel	09056
	Four way H-type parallel	09057
No. 2	Two way through box	08047
	Three way right angle	08048
	Four way right angle	08049

Use Catalogue No. when ordering.

All boxes are supplied standard with built-in glands for SWA cable. Available in three sizes, No 0, 1 and 2, which will accommodate cables from 1.5 mm² x 2 core to 16 mm² x 4 core. Each size is available in a Two way through box, Three way right angle box and a Four way right angle box. In addition the No. 1 box is available in a Three way Y-type parallel and Four way H-type parallel entry configuration.

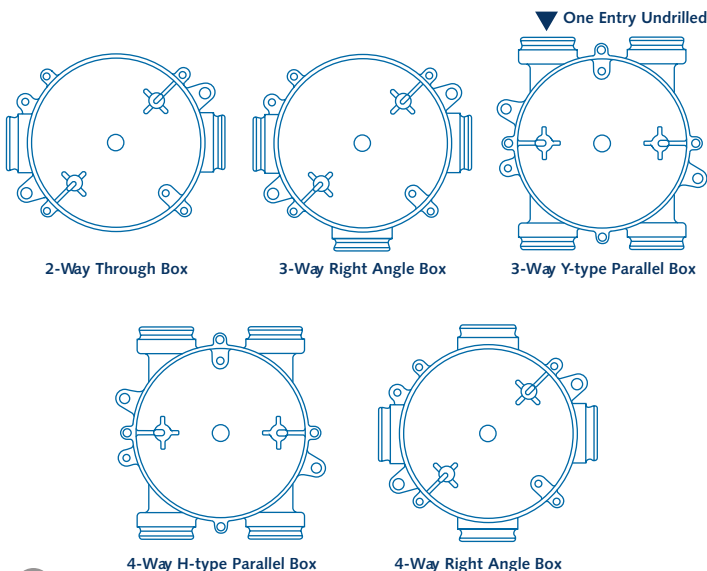

PRATLEY ALUMINIUM TUNNEL CABLE BOX

BS6387 compliant. These boxes are specially designed & certified for use in tunnels where fire and smoke considerations are paramount. They are supplied with special silicone shrouds manufactured for high temperatures & LSF.

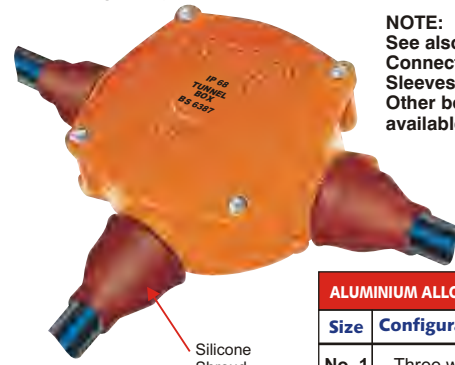

NOTE: See also Pratley End Connectors & Silicone Sleeves. Other box sizes also available on request.

ALUMINIUM ALLOY TUNNELBOX		
Size	Configuration	Cat. No.
No. 1	Three way	08234
No. 2	Three way	08239

ARMoured CABLE SELECTION CHART

This chart shows the maximum cable bedding diameter for each size of Cable Box.

NOTE: All Cable sizes marked* require the bedding to be measured, as the bedding diameters are close to the Gland bore size and the next larger size Cable Box may be required.

SWA/PVC CABLE BOX SELECTION CHART			
Cable Size	No. of Cores	Box Size	Max. Bedding Dia.
1.5 mm ²	2, 3, 4, 5	0	12.6 mm
	7	1	15.7 mm
	12	2	20.4 mm
2.5 mm ²	2, 3	0	12.6 mm
	4*	0 or 1	12.6/15.7 mm
	5, 7	1	15.7 mm
	12	2	20.4 mm
4.0 mm ²	2*	0 or 1	12.6/15.7 mm
	3, 4, 5	1	15.7 mm
	7	2	20.4 mm
6.0 mm ²	2, 3	1	15.7 mm
	4, 5, 7	2	20.4 mm
10.0 mm ²	2*	1 or 2	15.7/20.4 mm
	3, 4	2	20.4 mm
16.0 mm ²	2, 3, 4*	2	20.4 mm

UNIQUE BUILT-IN GLAND FOR CONVENIENCE

The Cable Boxes are supplied complete with Built-in Cable Glands for SWA/PVC Cables, which means that additional glands need not be purchased. The built-in glands will maintain IP68 rating against the ingress of water and dust. These glands can be easily converted for use with unarmoured cable (see accessories on Page 4).



EASE OF ELECTRICAL CONNECTION

The connection of the conductors can be achieved by either making use of Pratley Kwikbloks® mounted on a N35 "Tophat" rail or Pratley End Connectors and Insulating Sleeves. When making use of the End connectors, the conductors can be left long, so that the connection can be easily done outside the box and then folded back inside.



The Aluminium Alloy Junction Box allows work to be done outside the confines of the box.

FACTORY FITTED TO CUSTOMERS SPECIFICATIONS

Junction boxes can be factory fitted with a N35 mounting rail and Pratley Kwikbloks® to the customer's requirement. See chart below for number of Pratley Kwikbloks® per cable box. The built-in glands can be factory fitted with Reducing Glands and Shrouds or with Compression Conversion Kits for unarmoured cable. (See accessories overleaf). Pre cut lengths of cable can also be factory fitted.



Factory fitted Kwikbloks® inside Aluminium Alloy Junction Box.

NUMBER OF PRATLEY KWIKBLOKS® PER CABLE BOX								
Box Size	IK3 750/800V 27A 0.5 - 4 mm²		IK5 750/800V 36A 0.5 - 6 mm²		IK10 750/800V 67A 0.5 - 10 mm²		IK16 750/800V 87A 0.5 - 16 mm²	
	Max.	Prac.	Max.	Prac.	Max.	Prac.	Max.	Prac.
0	8	8	6	5	N/A	N/A	N/A	N/A
1	11	10	9	8	6	6	N/A	N/A
2	17	16	14	14	10	8	8	8

Max.: Number of Kwikbloks® that can be fitted.
Prac.: Practical number of Kwikbloks® to be fitted (Recommended).

ALUMINIUM ALLOY No.0 INSTRUMENTATION CABLE BOX

For use when terminating extra small (Xs) diameter unarmoured instrumentation cables. Supplied complete with built-in Xs Conversion Kits for 3 mm to 6 mm diameter unarmoured cables.

NOTE: Kwikbloks® and mounting rail for Kwikbloks® must be ordered separately.

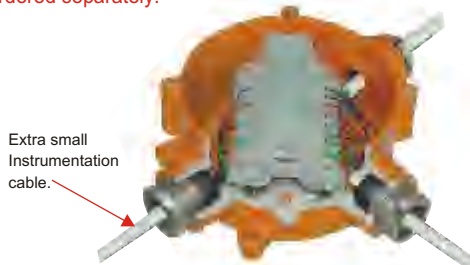

Extra small Instrumentation cable.

PRATLEY INSTRUMENTATION CABLE BOX			
Size	Configuration	Cat. No.	Usual pack Qty.
0	Two way through box	08050	1
	Three way right angle	08051	1
	Four way right angle	08052	1

Use Catalogue Number when ordering.

ALUMINIUM ALLOY CONDUIT BOXES

These boxes accept 20 mm Conduit directly. Shrouds are not required.



Box accepts conduit directly.

PRATLEY ALUMINIUM ALLOY CONDUIT BOX			
Size	Configuration	Cat. No.	Usual pack Qty.
0	Two way through box	07038	1
	Three way right angle	07039	1
	Four way right angle	07040	1

Use Catalogue Number when ordering.

DIMENSIONS & SPECIFICATIONS

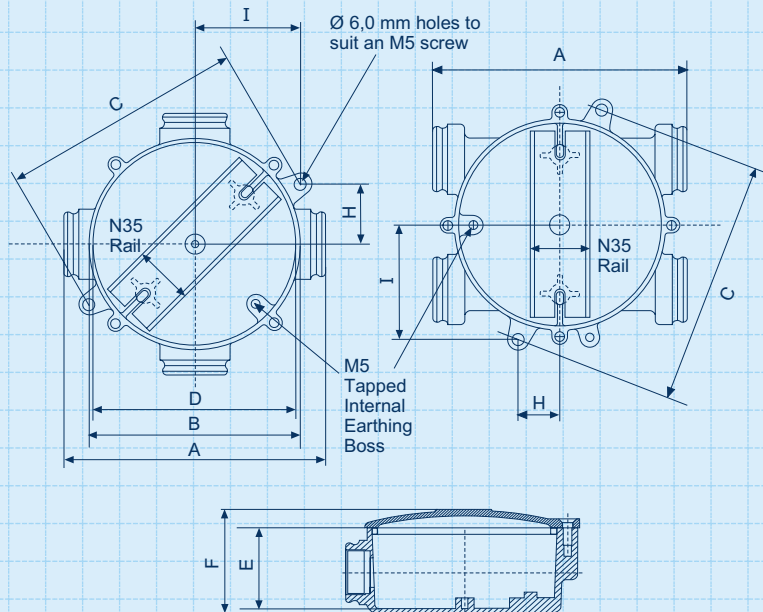

DIMENSIONS				
Box Number	No. 0	No. 1	No. 2	No. 1 PE
A Over 2 Entries	117.0 mm	131.5 mm	168.0 mm	129.5 mm
B Outer Diameter of Box	87.5 mm	105.5 mm	133.0 mm	107.0 mm
C Lug Centres	98.5 mm	124.0 mm	147.3 mm	124.0 mm
D Inner Diameter of Box	83.4 mm	101.0 mm	128.0 mm	102.5 mm
E Internal Depth	41.7 mm	45.0 mm	54.0 mm	45.0 mm
F Overall Height	54.0 mm	58.6 mm	71.5 mm	58.6 mm
G Entry Thread	M20 x 1.5P	M20 x 1.5P	M32 x 1.5P	M25 x 1.5P
H Lug Co-ordinates	24.63	31.0	36.8	16.0
I Lug Co-ordinates	42.65	53.7	63.8	60.0

SPECIFICATION GUIDE

The Junction box must be:

- Carry the SABS mark and be IP68 rated in accordance with SANS(IEC) 60529.
- Be suitable for use in DIP Zone 21 and 22 hazardous locations, according to SANS(IEC) 61241-1-1.
- Be made from aluminium alloy, epoxy coated with provision for the fitting of N35 rail mounted connectors.
- Be supplied with built-in, inner-sealed cable glands for SWA cable, which can be converted for use with unarmoured cable as well.
- Be provided with an internal earth boss and an external earth lug.
- Have a lid with a replaceable lid gasket and captively held stainless steel screws.

*NOTE: Specifiers may use this wording to specify the Pratley Aluminium Alloy Junction Box.

PACKAGING DATA

All Cable Boxes are packed in a cardboard pack, which is then packed into a cardboard shipping carton.

Box Size	Pack Dimensions	Weight (g)	Volume (m³)
No. 0 x 2 way	108 x 108 x 56 mm	336	0.00065
No. 0 x 3 way	108 x 108 x 56 mm	374	0.00065
No. 0 x 4 way	108 x 108 x 56 mm	406	0.00065
No. 1 x 2 way	128 x 137 x 59 mm	474	0.00093
No. 1 x 3 way	128 x 137 x 59 mm	518	0.00093
No. 1 x 4 way	128 x 137 x 59 mm	592	0.00093
No.1 x 3 way Y-type parallel	128 x 145 x 59 mm	592	0.00093
No.1 x 4 way H-type parallel	128 x 145 x 59 mm	592	0.00093
No. 2 x 2 way	150 x 150 x 72 mm	810	0.00135
No. 2 x 3 way	150 x 150 x 72 mm	888	0.00135
No. 2 x 4 way	150 x 150 x 72 mm	978	0.00135

ACCESSORIES

Refer to the following Sales Leaflets for further detailed information on:
 Pratley Kwikbloks® - Sales Leaflet No. 061
 Pratley End Connectors and sleeves - Sales Leaflet No. 060

COMPRESSION CONVERSION KITS FOR UNARMoured CABLE

By simply replacing the Cone Bush and inner Seal Bush with a Compression Conversion Kit, the built-in gland can accommodate unarmoured cables. The Xs (extra small) Compression Conversion Kits are available for unarmoured cables as small as 3 mm in diameter (see below).



PRATLEY COMPRESSION CONVERSION KITS				
Size	Cat. No.	Cable Range		Usual pack Qty.
		Min.	Max.	
0S	67075	6.0 mm	9.4 mm	10
0L	67082	9.5 mm	12.6 mm	10
1S	67076	12.7 mm	14.3 mm	10
1L	67083	14.4 mm	15.7 mm	10
2S	67077	15.8 mm	17.3 mm	10
2L	67084	17.4 mm	20.4 mm	10

COMPRESSION CONVERSION KITS FOR EXTRA SMALL CABLE

The No. 0xs kit reduces the capacity of the No. 0 box to accommodate small diameter instrumentation cable.



PRATLEY No. 0xs COMPRESSION CONVERSION KIT FOR No. 0 BOX			
Size	Cat. No.	Cable Dia.	Usual pack Qty.
0XS	67074	3-6 mm	10

REDUCING GLANDS AND SHROUDS

By simply replacing the gland with a Reducing Gland, smaller diameter SWA cables can be accommodated. For example a size '2 to 0' will reduce a No. 2 box entry to that of a No. 0 box entry.

Note: Smaller diameter unarmoured cables can be accommodated by using a Reducing Gland and a Compression Conversion Kit.



PRATLEY REDUCING GLANDS			
Box Size	Catalogue Number	Gland Size	Usual pack Quantity
1	11062	1 to 0	10
2	11063	2 to 0	10
2	11064	2 to 1	10

PRATLEY REDUCING SHROUDS		
Size	Cat. No.	Usual pack Qty.
1R	35111	10
2R	35211	10

BLANKING PLUGS

Are provided for use on spare cable entries. Plugs are available in either nickel plated brass or Tufflon. Blanking Plugs are supplied complete with sealing gaskets.



PRATLEY BLANKING PLUGS			
Size	Nickel Plated Brass	Tufflon	Usual pack Qty.
	Cat. No.	Cat. No.	
No. 0	61080	57800	10
No. 1	61081	57801	10
No. 2	61082	57802	10

CONDUIT ADAPTORS

These reduce the size of the box entry to receive conduit. They are supplied complete with sealing gaskets and are fitted to the box entry after the original built-in gland parts have been removed.



PRATLEY CONDUIT ADAPTORS				
Box No.	To	Conduit	Cat. No.	Usual pack Qty.
1	→	20 mm	48051	10
2	→	20 mm	48053	10
2	→	25 mm	48054	10

WATERPROOFING SHROUDS

Boxes can be purchased with waterproofing shrouds, which cover the complete gland and fit into the shroud groove of the built-in gland entry. Note: Shrouds must be ordered separately. (see also Reducing Glands and Shrouds above).



PRATLEY WATERPROOFING SHROUDS			
Size	Cat. No. (Short Shroud)	Usual pack Qty.	
0	03010	20	
1	03011	20	
2	03012	20	

SILICONE SHROUDS (Tunnel Box)

For use primarily with the Pratley Tunnel Box in extremely high temperatures and are fire resistant. They are halogen free & low fume & smoke. They have the same dimensions as standard shrouds.



PRATLEY SILICONE SHROUDS			
Size	Cat. No. (Short Shroud)	Usual pack Qty.	
0	03020	20	
1	03021	20	
2	03022	20	

SEE-THROUGH POLYCARBONATE COVERS

The No. 1 and No. 2 Cable Boxes can be fitted with see-through Polycarbonate Covers for ease of inspection and fault-finding. The covers have easily replaceable gaskets (see below).



PRATLEY POLYCARBONATE COVERS		
Size	Cat. No.	Usual pack Qty.
1	57111	1
2	57112	1

REPLACEMENT COVER GASKETS

The gaskets ensure a waterproof (IP68) seal and are very fast to fit. Gaskets should be replaced whenever inspection reveals deterioration.



STANDARD LID GASKETS			
Size	Cat. No.	Pack Qty.	
0	08151	1	
1	08152	1	
2	08153	1	

POLYCARBONATE LID GASKETS			
Size	Cat. No.	Pack Qty.	
1	57098	1	
2	57099	1	

MOUNTING LIDS

A mounting lid with an 80 mm sq. cutout can be fitted to the No. 2 Aluminium Alloy Cable Box. This enables the mounting of a flat plate, which can be drilled to permit easy mounting of meters, controls, gauges, lights, switches and the like.

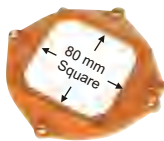

AA BOX MOUNTING LID		
Size	No. 2	
Cat. No.	08203	
Usual pack Qty.	1	

METRIC 5 mm BRASS EARTHING SCREWS

The Earthing Screw, with washers, may be purchased separately and fitted to the earthing boss inside the cable box for an internal earth connection.



BRASS EARTHING SCREW		
Size	5 mm Ø	
Cat. No.	08150	
Usual pack Qty.	1	

ALUMINIUM ALLOY BOX GLAND PARTS KIT (For SWA cable)

Nickel plated Brass built-in Glands are supplied with the box. These Glands' Parts can however also be supplied separately if required.

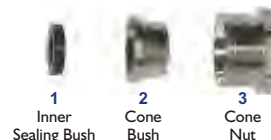

PRATLEY AA BOX GLAND PARTS KIT		
Size	Cat. No.	Usual pack Qty.
No. 0	08102	1
No. 1	08103	1
No. 2	08104	1

PRATLEY END CONNECTORS AND INSULATING SLEEVES (Not for Ex e applications)

Pratley Non-sparking and Standard Connectors may be used with Pratley Aluminium Alloy Junction Boxes in DIP and non Ex applications respectively.



STANDARD RANGE			
Size	Cat. No.	Pack Qty.	
2	18110	100	
3	18111	50	
4	18112	20	
5	18113	20	
6	18114	20	

NON-SPARKING RANGE			
Size	Cat. No.	Pack Qty.	
Dinky	63200	100	
Small	63201	50	
Medium	63202	20	
Large	63203	20	
Extra Large	63204	20	

INSULATING SLEEVES			
Size	Cat. No.	Pack Qty.	
2/D	04014	50	
3/S	04015	25	
4/M	04016	20	
5/L	04017	10	
6/XL	04018	10	

PRATLEY SILICONE SLEEVES (Not for Ex e applications)

Designed for use in extremely high temperatures and are fire resistant. They are halogen free and low fume & smoke. See also - Pratley Tunnel Box.



SILICONE SLEEVES		
Size	Cat. No.	Pack Qty.
2/D	04030	50
3/S	04031	25